



# BASIC

## Series 1 & 2

Basic electric strikes are ideal for simple ironmongery installations, such as **home door phones**. They are available with fixed or adjustable keeper, for either DIN right or left doors.

Featuring a wide variety of functions and voltages, these strikes quickly unlock standard doors through low power consumption.

## Technical features

- Max. side-load on AC: 160 N  
Max. side-load on DC: 10 N
- Break-in resistance: 3.000 N
- Operating temperature range: -15 °C / +40 °C
- Housing: Zamak  
Keeper: Zamak
- Guaranteed 3 years
- Complies with 2004/108/CE (EN 55014)
- Corrosion resistant according to UNI ISO 9227

## Coil features

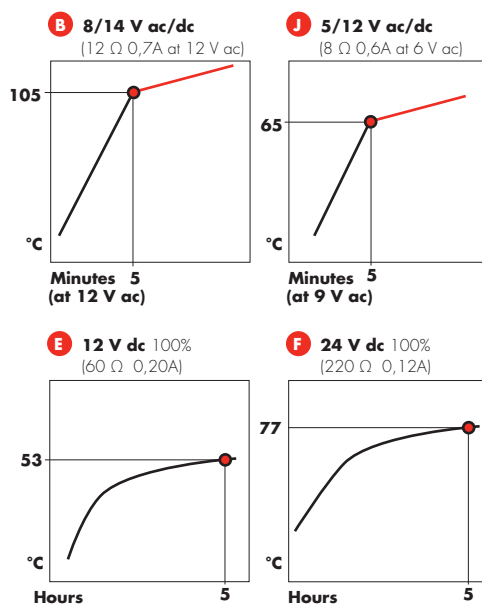

Personalized coils upon request

## References and features

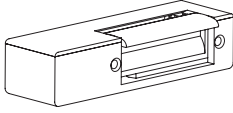
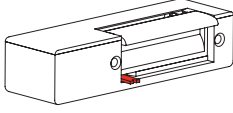
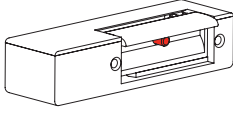
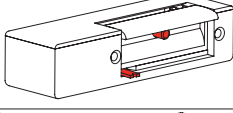
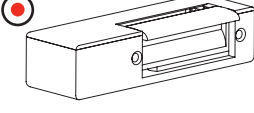
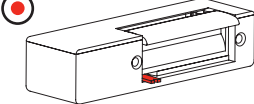
	Fixed keeper	Adjustable keeper	Side-load	Voltage	References DIN right add faceplate	References DIN left add faceplate	
 <b>Fail-secure</b>	●		●	8-14 V ac/dc	<b>10.0.00.B</b>	<b>20.0.00.B</b>	
	●		●	5-12 V ac/dc	<b>10.0.00.J</b>	<b>20.0.00.J</b>	
	●			12 V dc	<b>10.0.00.E</b>	<b>20.0.00.E</b>	
	●			24 V dc	<b>10.0.00.F</b>	<b>20.0.00.F</b>	
		●	●	8-14 V ac/dc	<b>10.1.00.B</b>	<b>20.1.00.B</b>	
		●	●	5-12 V ac/dc	<b>10.1.00.J</b>	<b>20.1.00.J</b>	
 <b>Fail-secure with mechanical unlocking</b>	●		●	8-14 V ac/dc	<b>11.0.00.B</b>	<b>21.0.00.B</b>	
	●		●	5-12 V ac/dc	<b>11.0.00.J</b>	<b>21.0.00.J</b>	
	●			12 V dc	<b>11.0.00.E</b>	<b>21.0.00.E</b>	
	●			24 V dc	<b>11.0.00.F</b>	<b>21.0.00.F</b>	
		●	●	8-14 V ac/dc	<b>11.1.00.B</b>	<b>21.1.00.B</b>	
		●	●	5-12 V ac/dc	<b>11.1.00.J</b>	<b>21.1.00.J</b>	
 <b>Hold-open</b>	●		●	8-14 V ac/dc	<b>12.0.00.B</b>	<b>22.0.00.B</b>	
	●		●	5-12 V ac/dc	<b>12.0.00.J</b>	<b>22.0.00.J</b>	
		●	●	8-14 V ac/dc	<b>12.1.00.B</b>	<b>22.1.00.B</b>	
		●	●	5-12 V ac/dc	<b>12.1.00.J</b>	<b>22.1.00.J</b>	
	 <b>Hold-open with mechanical unlocking</b>	●		●	8-14 V ac/dc	<b>13.0.00.B</b>	<b>23.0.00.B</b>
		●		●	5-12 V ac/dc	<b>13.0.00.J</b>	<b>23.0.00.J</b>
		●	●	8-14 V ac/dc	<b>13.1.00.B</b>	<b>23.1.00.B</b>	
		●	●	5-12 V ac/dc	<b>13.1.00.J</b>	<b>23.1.00.J</b>	
 <b>Internal Hold-open</b>		●		●	9-14 V ac/dc	<b>12A.0.00.B</b>	<b>22A.0.00.B</b>
		●		●	6-12 V ac/dc	<b>12A.0.00.J</b>	<b>22A.0.00.J</b>
		●	●	9-14 V ac/dc	<b>12A.1.00.B</b>	<b>22A.1.00.B</b>	
		●	●	6-12 V ac/dc	<b>12A.1.00.J</b>	<b>22A.1.00.J</b>	
	 <b>Internal Hold-open with mechanical unlocking</b>	●		●	9-14 V ac/dc	<b>13A.0.00.B</b>	<b>23A.0.00.B</b>
		●		●	6-12 V ac/dc	<b>13A.0.00.J</b>	<b>23A.0.00.J</b>
		●	●	9-14 V ac/dc	<b>13A.1.00.B</b>	<b>23A.1.00.B</b>	
		●	●	6-12 V ac/dc	<b>13A.1.00.J</b>	<b>23A.1.00.J</b>	

## Recommended Faceplates

SHORT	LONG	ANGLED
01 Grey	03 Grey Brown	08 Brown
61 Inox	04 Grey Brown	09 Brown
66 Inox	05 Grey Brown	10 Brown
	20 Inox	11 Brown
<b>BOX</b>	21 Inox	12 Brown
	43 Inox	13 Brown
80 Grey	63 Inox	14 Brown
81 Grey	64 Inox	15 Brown
	65 Inox	16 Brown
84 Grey	67 Inox	17 Brown
Chrome	73 Inox	
Brass	74 Inox	
	C3 Grey Brown	
	C4 Grey Brown	
	C5 Grey Brown	
	C63 Inox	
	C64 Inox	
	C65 Inox	
	D3 Grey Brown	
	D4 Grey Brown	

## Shallow adjustable keeper

Supplied upon request

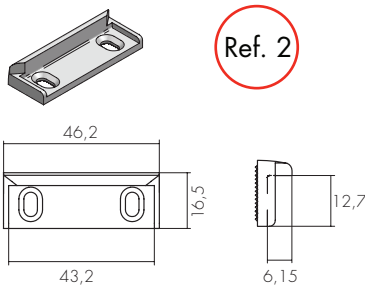

Ref. 2

## Deep adjustable keeper

Supplied upon request

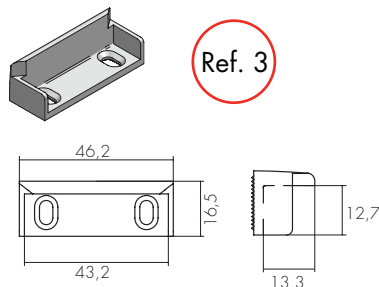

Ref. 3

## Shim kit

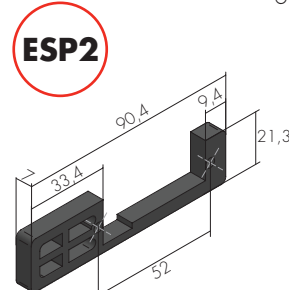

ESP2

## Dimensions

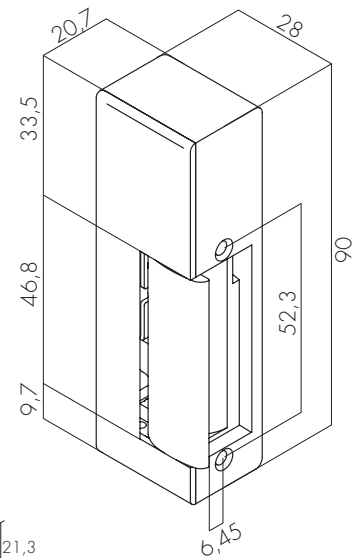

Keeper's adjustability: 3 mm