

Door Release Button

800412

Door release Button

- Suitable for door , Hollow Door
- Standard structure :
Aluminum panel sandblast finished
Metal Button
- Output contact : NO/NC/COM
- Current Rating : 3A 36vDC Max.
- Operating temp. : 10~ +55°C
- Operating Humidity : 0-95%
- Size : 86Lx86Wx28.9H mm

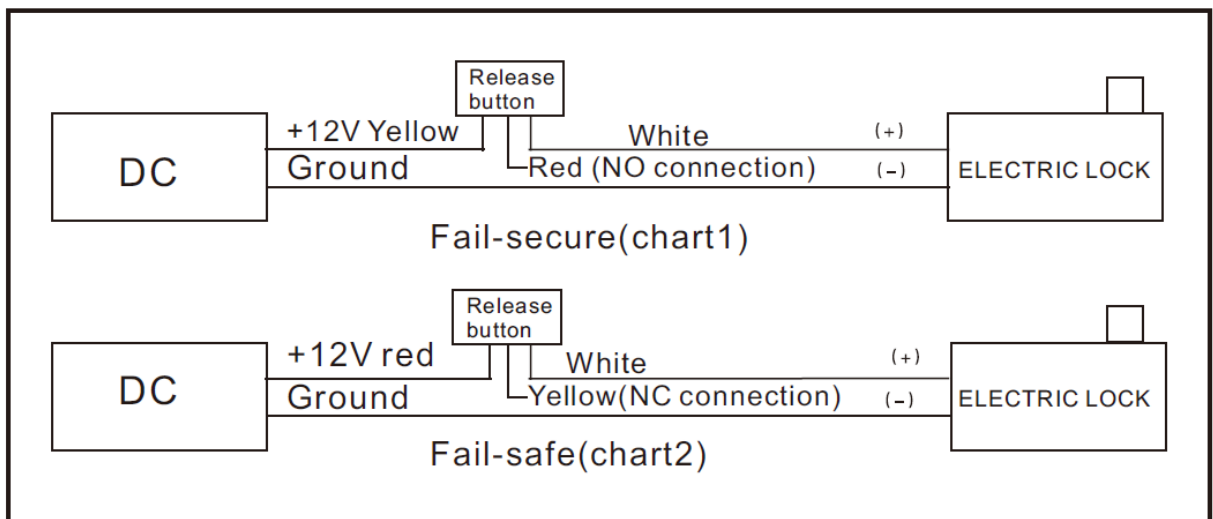
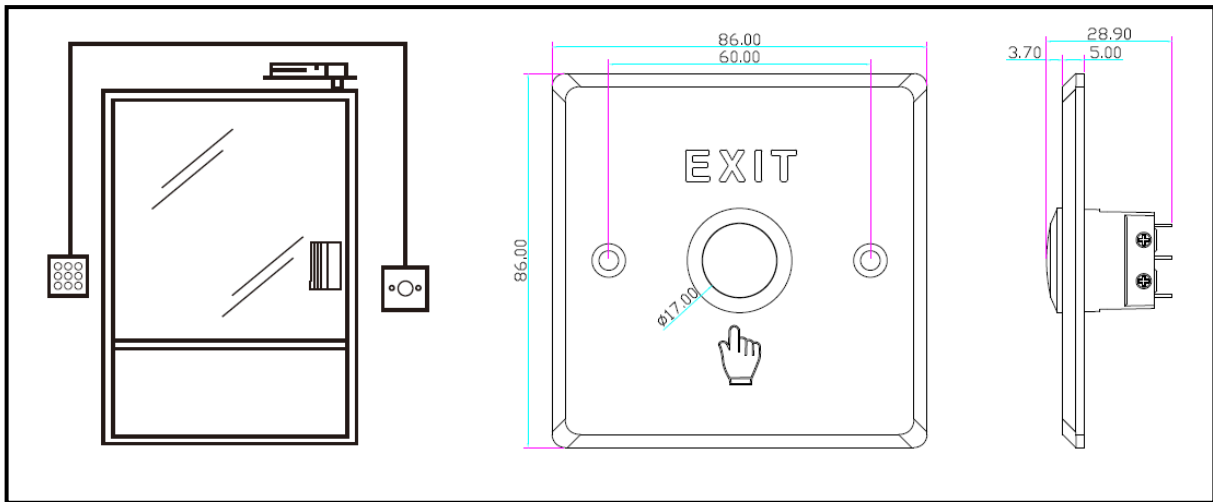

VandaVeto®